



Colour Guide

The colours in the tables will help you select your products material and finish. These will also be displayed in the page footer throughout this section. Products not colour coded will state their material or finish below the table.

	Grade 304 Stainless steel (Internal)
	Grade 316 Stainless steel (External)
	Zamac (Zinc aluminium alloy)
	Zinc coated steel
	Mild steel
	Galvanised steel
	Aluminium
	Duplex 2205 (Ultra marine stainless)

Icons

Throughout this section there are various icons to help you with your product selection.

-  Diameter
-  Square Solid
-  Square Hollow



Technical information that can be found on our website



Scan for more information

Decking & Subframe





Index

Adjustable Pedestals.....	370-371
Aluminium	
Decking Substructure.....	369-376
Decking System.....	374-378
Deck Trims.....	383
Subframe.....	368-376
Composite Decking.....	361-366
Cradles & Pedestals.....	370-376
Decking Clips for WPC Decking.....	366
Decking Fascias & Trims for WPC Decking.....	362-365
Polymer Subframe.....	372
Porcelain Decking.....	379-381
Rinato™ Decking.....	361-366
Classic Range.....	365
Natural Range.....	263-263
Victoria Range.....	364
Rynodeck™ Support System.....	368-371
Synergised™ Decking System.....	
Connected.....	377-378
Original.....	374-376
Perimeter Base System.....	382
Synergised™ Porcelain Tiles.....	379-381
Synergised Paving Clips.....	376
Tile Adhesive.....	381
WPC Decking.....	361-366

Decking & Subframe
website section



Create a stunning finish with Rinato™ deck boards





Rinato™ Deck Boards

The look of wood without the hassle



With our range of composite deck boards there is a style, colour and price to suit everyone. These boards are easy to install and look fantastic. As well as being environmentally friendly, all our decking is virtually maintenance free, is incredibly durable and will remain so for years to come. Experience the beauty of wood without the hassle.

Features

- | | | |
|---------------------------------|-------------------------------|-----------------------------|
| Virtually maintenance free | Anti-slip resistance tested | Made from recycled material |
| Easy to keep clean & stain free | Easy to install | Recyclable |
| Excellent UV resistance | Workability - similar to wood | Non-toxic |
| Splinter free | Solid & hollow core options | Flammability tested |

Available In Three Ranges:

Natural - Features a 360 degree wrap around Polymer Capstock shield that encapsulates the hollow core deck board and gives it year-round protection against the elements and is suitable for a variety of outdoor uses. Available in 3 colours and with an enhanced natural woodgrain effect one side and traditional flat sanded effect the other.

Victoria - Uses less composite material thanks to the 'M' design on the underside, making the board lighter and more economic, the perfect cost-friendly choice for every garden, balcony or patio. Available in 4 colours, boards are single-sided with a choice of natural woodgrain effect or a traditional grooved effect across all the colours.

Classic - With a choice of 4 colours these solid core deck boards have an enhanced natural wood grain effect one side and traditional grooved effect other. These solid deck boards are great for areas of high footfall or weight, such as under a hot tub or any commercial application.

All our deck boards are supported with a UK backed warranty.



You can order online 24 hours a day, 7 days a week.
Visit our website: www.fhbrundle.co.uk

Scan here to order a free sample.



Steel
Wrought Iron Components
Gate Hardware
Sliding Door Gear
Gate Automation
Mesh
Decking & Subframe
Flooring & Stair Treads
Handrailing
Fencing
Fixings



Cedar Dawn

Platinum Ash

Twilight Grey



Deck Boards - Double-Sided



Length m	Width mm	Depth mm	Code
3.66	140	22	70CD001

Length m	Width mm	Depth mm	Code
3.66	140	22	70PA001

Length m	Width mm	Depth mm	Code
3.66	140	22	70TG001

Starter Boards (used at the start of a run to hide starter clips)

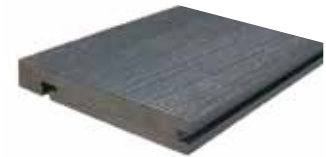
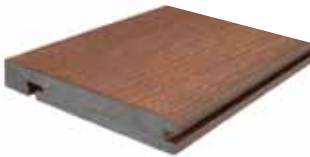

Length m	Width mm	Depth mm	Code
3.66	140	22	70CD005

Length m	Width mm	Depth mm	Code
3.66	140	22	70PA005

Length m	Width mm	Depth mm	Code
3.66	140	22	70TG005

Fascia Boards



Length m	Width mm	Depth mm	Code
3.66	70	10	70CD004

Length m	Width mm	Depth mm	Code
3.66	70	10	70PA004

Length m	Width mm	Depth mm	Code
3.66	70	10	70TG004

Grooved L Shaped Trims

Cedar Dawn



Length m	Width mm	Depth mm	Code
3.66	50	50	70CD003A

Platinum Ash



Length m	Width mm	Depth mm	Code
3.66	50	50	70PA003A

Twilight Grey



Length m	Width mm	Depth mm	Code
3.66	50	50	70TG003A

Fixings

Starter Clip

- Used to start a run of deck boards
- Supplied in packs of 10 with screws



Pack Quantity	Code
10	66SC01

10 clips are recommended for each perimeter/starter board.

Double Clip

- 1.5mm gap between deck boards
- Supplied in packs of 50 with screws



Pack Quantity	Code
50	66DC01

9 clips are recommended for each board length.

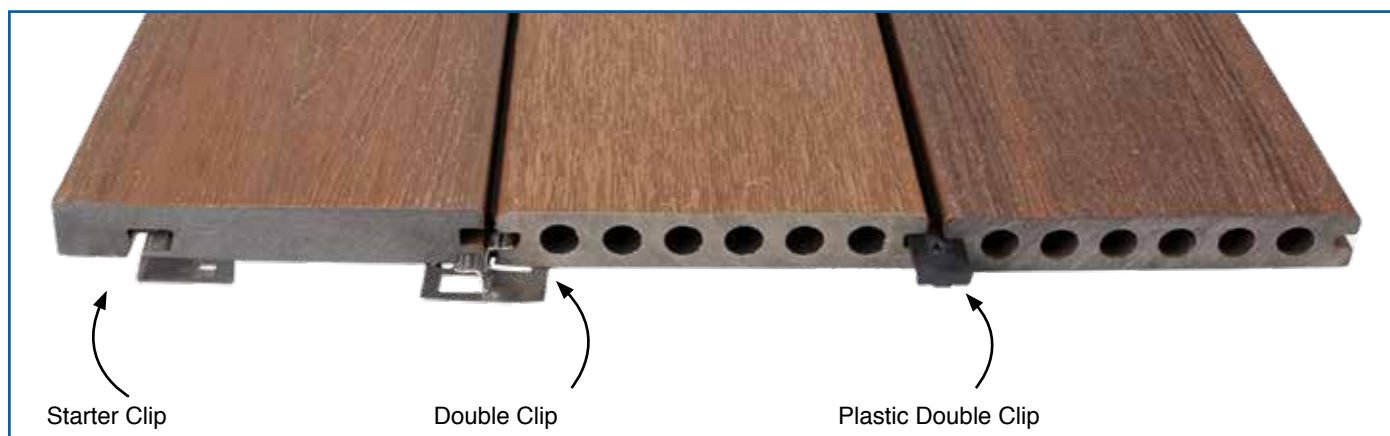

Starter Clip

Double Clip

Plastic Double Clip

Request a free deck board sample.

Scan here to download our Natural Range installation guide.



Decking Calculator

For decking we have a simple to use calculator to help select the numbers of deck boards and clips you will need. Our range of decking covers a wide choice of eco-friendly boards and modern colours, to bring your vision to life.

liveconfigurator.co.uk

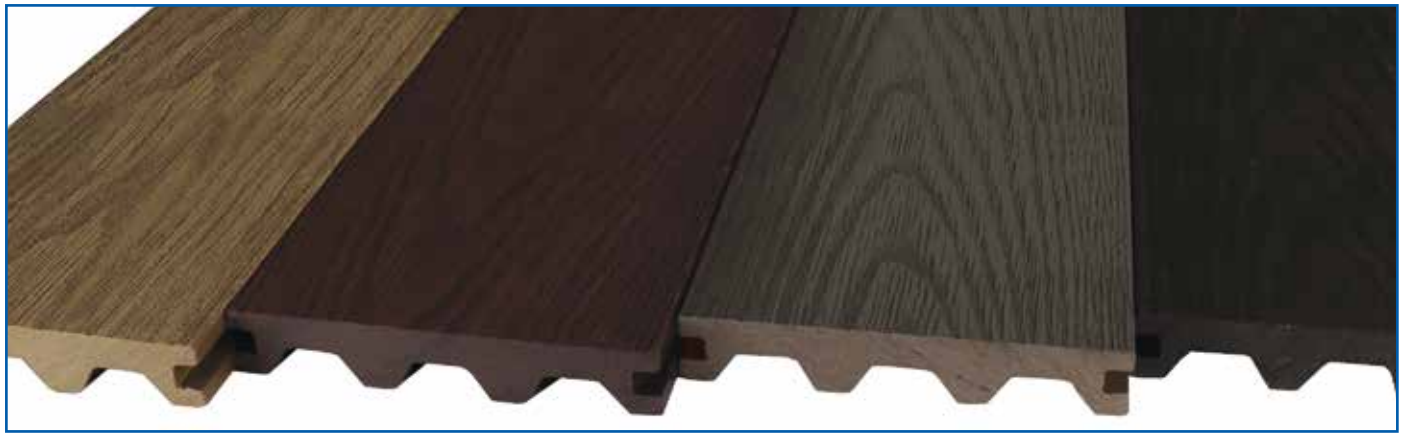

Teak

Redwood

Grey

Ebony



Wood Grain Deck Board

Wood Grain Deck Board

Wood Grain Deck Board

Wood Grain Deck Board

Length m	Width mm	Depth mm	Code
3.6	135	23	71T004

Length m	Width mm	Depth mm	Code
3.6	135	23	71R004

Length m	Width mm	Depth mm	Code
3.6	135	23	71G004

Length m	Width mm	Depth mm	Code
3.6	135	23	71E004

Grooved Deck Board

Grooved Deck Board

Grooved Deck Board

Grooved Deck Board

Length m	Width mm	Depth mm	Code
3.6	135	23	71T003

Length m	Width mm	Depth mm	Code
3.6	135	23	71R003

Length m	Width mm	Depth mm	Code
3.6	135	23	71G003

Length m	Width mm	Depth mm	Code
3.6	135	23	71E003

Starter Boards - Only For The Victoria Range



Length m	Width mm	Depth mm	Code
2.4	168	23	71T005

Length m	Width mm	Depth mm	Code
2.4	168	23	71R005

Length m	Width mm	Depth mm	Code
2.4	168	23	71G005

Length m	Width mm	Depth mm	Code
2.4	168	23	71E005

Fixings

Starter Clip

- Screws sold separately
- Stainless steel & PPC black



Pack Quantity	Code
1	71SC003
25	71SC003P

10 clips are recommended for each perimeter/starter board.

Double Clip

- 7mm gap between deck boards
- Screws sold separately
- Stainless steel & PPC black



Pack Quantity	Code
1	71DC003

12 clips are recommended for each board length.

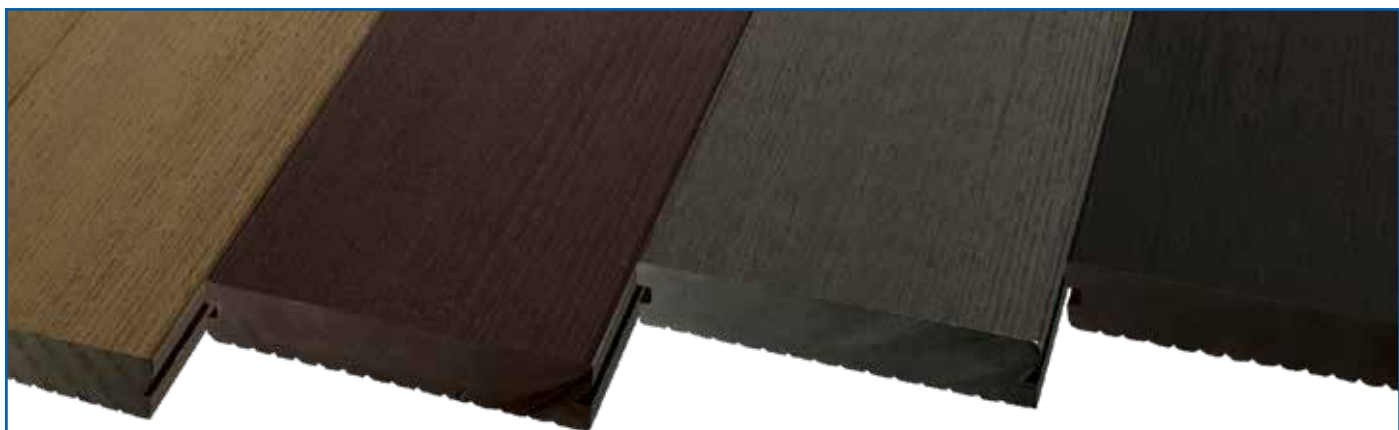

Teak

Redwood

Grey

Ebony



Double-Sided Deck Board

Double-Sided Deck Board

Double-Sided Deck Board

Double-Sided Deck Board

Length m	Width mm	Depth mm	Code
3.6	150	25	71T001

Length m	Width mm	Depth mm	Code
3.6	150	25	71R001

Length m	Width mm	Depth mm	Code
3.6	150	25	71G001

Length m	Width mm	Depth mm	Code
3.6	150	25	71E001

Fascia Boards - Double-Sided - For Use With Victoria & Classic

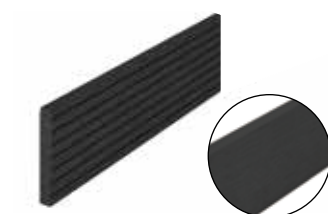
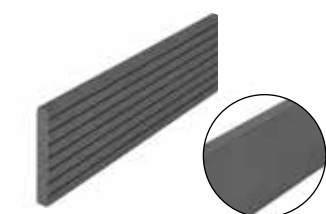
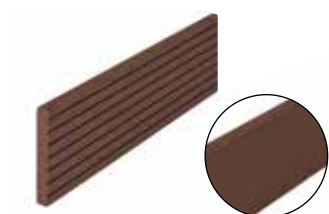
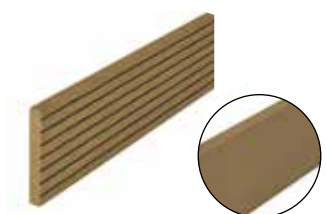

Length m	Width mm	Depth mm	Code
2.4	60	10	71T002

Length m	Width mm	Depth mm	Code
2.4	60	10	71R002

Length m	Width mm	Depth mm	Code
2.4	60	10	71G002

Length m	Width mm	Depth mm	Code
2.4	60	10	71E002

Fixings

Nylon Fixing Clips

- Economical decking clips
- Supplied in a pack of 100



Code
71DCN003P

Screws

- Supplied in a pack of 100
- Stainless steel & PPC black



Code
71SS003

Screw Driver Bit

- T15 Torx head
- 50mm long
- Supplied in a pack of 2



Code
66TX001

For our full range of fixing clips see page 366.

For our range of aluminium decking trims see page 383.

9 clips are recommended for each board length.

Decking substructure & pedestals from page 368.

Scan here to download our Victoria & Classic installation guide.



Full range of fixing clips



No.	Type	Material	Colour	Gap Between Boards mm	Number of Clips per Pack	Number of Clips Needed per sq/m	Clip Code	Screws Included	Screw Code	Number of Screws per Pack
1	Starter Clip	Stainless Steel	Silver	0	10	N/A	66SC01	Yes	N/A	N/A
2	Double Clip	Stainless Steel	Silver	1.5*	50	18	66DC01	Yes	N/A	N/A
3	Starter Clip	Stainless Steel	Black	7	1	N/A	71SC003	No	71SS003	100
	Starter Clip	Stainless Steel	Black	0	25	N/A	71SC003P	No	71SS003	100
4	Double Clip	Stainless Steel	Black	7	1	18	71DC003	No	71SS003	100
5	Double Clip	Nylon	Black	7	100	18	71DCN003P	No	71SS003	100

*Except Classic boards where the gap is 5mm. For screw driver bit use code: 66TX001.

NB. We recommend 9 clips per board length when using Natural and Classic boards and 12 clips per board length when using Victoria boards.

We also recommend using 10 starter clips per perimeter/starter board across the range.

A range of handrailing perfectly designed for decking



FOR MORE INFORMATION VISIT
www.fhbrundle.co.uk

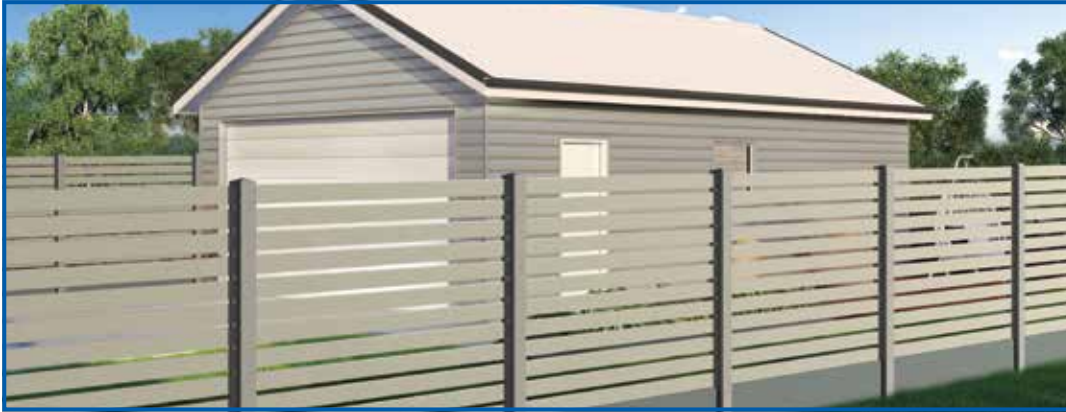

As awareness has grown of the advantages to using aluminium in the construction of gates and railings, so has our range of extrusions. Marano Integrated offers long lasting, lightweight aluminium boards with total flexibility.

This fencing solution can provide either complete privacy or open boards mixed in with contemporary laser cut screens to add some decorative design to the garden. All the boards and full height screens can be used in conjunction with each other.

Steel fabricators and gate makers can easily incorporate these boards into steel gate frames and rely on the extensive F.H. Brundle range of steel sections, gate hardware and automation to create matching gates specific to customers' needs.



This fencing system is available in four powder coated matt finish boards or alternatively a mill finish, to allow you to powder coat to your preferred choice of RAL colour. Marano Integrated is aluminium, so it is lightweight and easy to work with. For fences lower than 1.8m, or for bolt down post requirements, posts can be cut to size on site. Additional information can be found on page 610.

One universal post can be used as a mid, end and corner post, just simply buy the additional extrusions you require. The four different styles of board can be used to create the different designs below. The boards are discretely integrated into the posts to hide all fixings and fastenings, with a cover cap that slides easily into place after fixing.

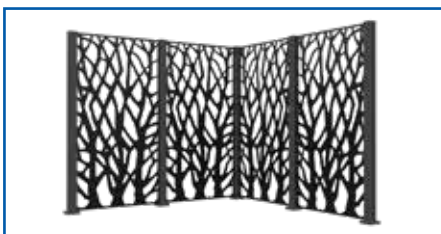

For more information or to place an order scan here.





RynoDeck™ support system is strong, durable and designed to make life easier. Quick to install and easy to adjust, they are very versatile and will stand the test of time. From domestic gardens to larger developments, RynoDeck support products are chosen because of their simple yet effective designs and ease of installation. Using the aluminium decking substructure along with the self-levelling adjustable pedestals or the adjustable support cradles will help create a stable, long lasting and eye-catching design.

Areas For Use:

- Gardens/domestic properties
- Structural podium decks
- Walkways
- Roofs, terraces, balconies, greenroofs
- Communal/public areas
- Wheelchair access ramps

Aluminium Decking Substructure



See page 369.

Self-Levelling Adjustable Decking Pedestals



See page 370.

Adjustable Decking Support Cradles



See page 371.

Aluminium Decking Substructure

Two sizes of aluminium joist profile cater for any deck support requirements. With a continuous fixing channel designed to offer optimum fixing strength, the profiles are compatible with any board width. Extruded to high quality standards, the RynoDeck aluminium substructure offers numerous benefits over other joist materials.

- Always completely straight, ensuring perfectly even decking
- Will not warp, twist, splinter or crack
- Superior longevity. The fact it will never rot ensures your deck will always have the support it needs
- Lighter than traditional methods, imposing less weight on supporting roof structures
- Greater strength to size ratio than traditional joists such as timber & composite joists

Self-Levelling Adjustable Decking Pedestals

The height range of the RynoDeck self-levelling adjustable pedestal allows it to overcome very large changes in surface level, providing slope correction of up to 10.5% and accommodating bearer widths of up to 100mm which can also conceal services, ductwork and pipes beneath the deck.

Decking Support Cradles

The RynoDeck adjustable decking cradle is ideal for low level decking offering joist support with infinite height adjustment between 10 – 40mm and a bearer width of 44 - 48mm.



Rynodeck™ Support System

Aluminium decking substructure



The RynoDeck™ support aluminium substructure system is the ultimate decking support solution. Its simple and sturdy design ensures rapid installation regardless of the complexity of the project. It has been designed to support any conventional decking system, making it the perfect solution for all decking applications. For use with RynoDeck self-levelling adjustable decking pedestals and adjustable decking support cradles.

Features:

- Ultimate decking support solution
- Simple design
- Rapid installation
- Compatible with all RynoDeck pedestals & cradles
- Supports any type of conventional decking boards softwood, hardwood, composite & PVC

Joist Profiles

38mm Profile



Length m	Width mm	Depth mm	Code
3.6	48	38	69DS38

Mill/Raw finish.

72mm Profile



Length m	Width mm	Depth mm	Code
3.6	48	72	69DS72

Mill/Raw finish.

Connections

Straight Joist Connector



To Suit Profile mm	Code
38	69DS38SC
72	69DS72SC

90° Angle Joist Connector



To Suit Profile mm	Code
38	69DS38CC90
72	69DS72CC90

135° Adjustable Angle Joist Connector



To Suit Profile mm	Code
38	69DS38CC135
72	69DS72CC135



Fixings (for use with aluminium joists)

Decking Screw

For plastic clips



Pack Qty	Code
100	69CS3938

Decking Screw

For metal clips



Pack Qty	Code
100	69CS3919

Joist Screw

For joist connectors



Pack Qty	Code
100	69PS4213

Steel

Wrought Iron Components

Gate Hardware

Sliding Door Gear

Gate Automation

Mesh

Decking & Subframe

Flooring & Stair Treads

Handrailing

Fencing

Fixings

Rynodeck™ Support System

Self-levelling adjustable decking pedestals



The RynoDeck™ support self-levelling adjustable pedestal is unrivalled in its field. Designed to support any type of decking or flooring joist up to 100mm width, it offers the highest compressive of any pedestal system on the market. Its unique self-levelling head and impressive height range will accommodate even the most complex decking issues including sloping areas, drainage and maintenance access.

Features:

- Self-levelling design offers slope correction up to 10.5% (6°)
- Ultimate compression strength for maximum durability
- Simple design ensures rapid installation
- For use with any joist size or type

Adjustable Decking Pedestal

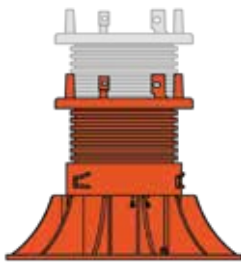

Exploded View Of Pedestal

Self-Levelling Bearer Support Head

- Due to its innovative self-levelling head design, RynoDeck has the fastest installation time of any pedestal system available.
- Utilises the 'ball & socket' joint concept to allow a free moving captive head
- Provides slope correction of up to 10.5% (6°)
- Decking is laid onto the pedestals without having to manually adjust slope correction. This results in significant time savings and a perfectly level finished area
- Can accommodate bearer width of up to 100mm

Adjustable Threaded Section

This heavy grade threaded section allows you to adjust the height in minute increments, within the given range. It's easy to adjust, simply grab and twist.

Height Extension Collar

A very simple design with a single 'click' motion to attach, these extension collars build up the pedestals in 100mm increments.

Wide Supporting Base

Pedestals are loose laid and do not require fixing to the floor

- Large diameter spreads loads and ensures stability
- Prevents damage to roof membranes and other substructures
- Can be fixed down into concrete, or loose laid on roof membranes etc
- Incorporates water drainage holes to prevent moisture build-up

Base Ø mm	Adjustable Height mm	Code
210	40 - 56	69RDA01
210	50 - 70	69RDA02
210	70 - 110	69RDA03
220	110 - 160	69RDA04
220	150 - 210	69RDA05

Sizes up to 1000mm high are available on request. Polypropylene.

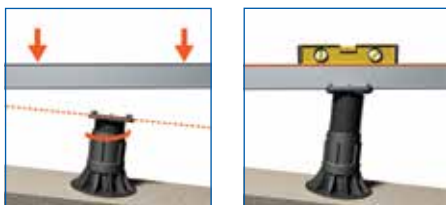

Versatile Head

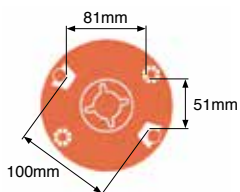

Multiple options allow for deck joist widths of up to 100mm.

Joist Width Up To 51mm



Allowing for joist widths of up to 51mm. Rotate until the fixing lugs meet the joist, then insert screws as required

Joist Width Up To 80mm

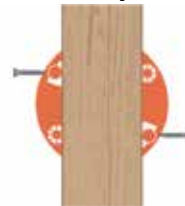

A wider bearer joist of up to 80mm can be inserted in an alternative set up.

Joist Width Up To 100mm



Furthermore any joist width up to 100mm can be supported as shown, removing the 'snap-off' lugs as required. This also allows for double joist support.



Rynodeck™ Support System

Adjustable decking support cradles



RynoDeck™ adjustable support cradles are the perfect solution where decking requires elevating off the ground by a minimal height. Designed to support any type of decking or flooring joist from 44 - 48mm width they are simple to install and adjust, plus they are an economical method of creating a clear space below the decking joists, which improves air circulation and can help to prevent rot.

Features:

- Supports very low decking applications, as low as 10mm
- Perfect for patio overlays/renovations
- Ideal for creating balcony decking areas

Low Height Adjustable Cradle

For joists less than 50mm high



Base Ø mm	Adjustable Height mm	Code
90	10 - 40	69RDC1040LH

Recycled nylon (glass filled).

Adjustable Cradle

For joists from 50 - 300mm high



Base Ø mm	Adjustable Height mm	Code
90	10 - 40	69RDC1040

Recycled nylon (glass filled).

Synergised™ Adjustable Pedestals

50mm

75mm

110mm

185mm

250mm



Top

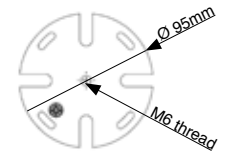

Base

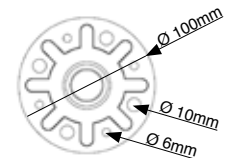

Code
79PED50

Adjustable from 50 - 75mm.

Code
79PED75

Adjustable from 75 - 115mm.

Code
79PED110

Adjustable from 110 - 185mm.

Code
79PED185

Adjustable from 185 - 260mm.

Code
79PED250

Adjustable from 250 - 325mm.

Adjustable pedestals are zinc passivated and can be used with a wide range of decking materials.

Polymer Profiles

Square & rectangular polymer decking substructure



A special decking substructure, which can be used as a standalone product or can be used with our pedestals or cradles. They are manufactured from 100% recycled plastic and are some of the strongest joists available on the market. Unlike wood or steel, the weather cannot harm it. It is virtually maintenance free and will last for many years.

Features:

- Weather resistant
- Produced without preservatives
- Long lasting
- Rot resistant
- Sustainably environmentally friendly
- Resistant to oils, brines, acids & salt water
- Splinter free
- Reduces the strain on landfills
- Low maintenance
- Moisture repellent - fast drying
- Made of high-quality processed secondary plastics

Square Sub Frame

Rectangular Sub Frame



Colour	Length m	Height mm	Width mm	Code
Black	3.60	50	50	7401505036B
Black	3.60	95	95	7401959536B
Brown	3.00	40	40	740140403BN
Brown	3.60	50	50	7401505036BN
Brown	3.60	95	95	7401959536BN

Colour	Length m	Height mm	Width mm	Code
Black	3.60	50	95	7401955036B
Brown	3.60	50	95	7401955036BN
Black	3.60	50	140	74011405036B
Brown	3.60	50	140	74011405036BN

Plastic.

Plastic.

MARANO[®]

LIGHT • STYLE • VISION

Aluminium fence boards - Modern gate solutions



- 6 superb styles to choose from
- Single or double sided option
- Fencing kits available

It's a lifestyle choice...



PRO-RAILING[®]
The Stainless Steel Handrail Component System

rinato[™] boards
without compromise

SYNERGISED[™]
INNOVATIVE DECKING SOLUTIONS

To see the full range of components used
to create this design scan Here



Synergised™ Original

Innovative fire rated aluminium decking solutions

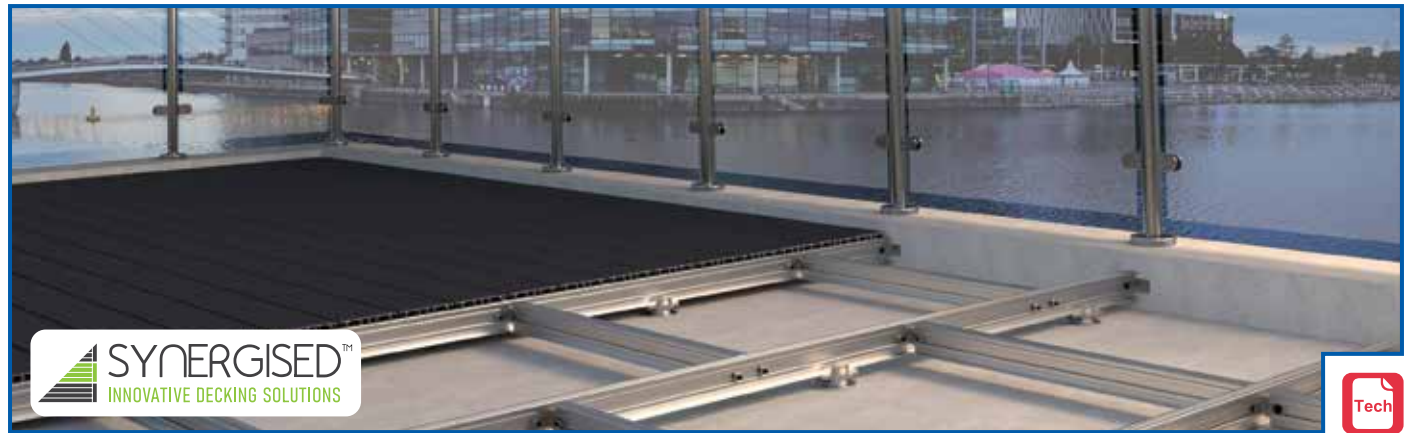

The Synergised range of aluminium deck products has been tested by the UK's leading fire test centre to EN 13823, EN 13501 and EN ISO 1716. All elements of the Synergised System achieve Euroclass Classifications of A1 and A2fl-s1. Available in 3 contemporary colours and manufactured from structural grade 6063 T6 aluminium with a 100 micron Qualicoat™ premium powder coating, these are the ideal decking solution for both residential and commercial high footfall environments such as high rise balconies, walkways, terraces, pubs, gardens and much more. Installation couldn't be easier, with our innovative cradle base and joist support system that offers up to 50% cost saving compared to other solutions. Once installed the system is long lasting and low maintenance with a manufacturer's limited warranty.

- A1 and A2fl-s1 fire rated
- Made from structural grade 6063 T6 aluminium
- Ideal for high rise concrete balconies & terraces
- Up to 50% cost saving when compared to other systems
- 100 micron Qualicoat™ premium powder coating
- Adjustable cradle and deck support system

- Joist spacing up to 800mm centres
- Low surface temperatures
- Long lasting and low maintenance
- Lightweight and easy to install
- Mill finish subframes and cradles
- 10 year warranty on powder coating



Scan here for our installation guide.

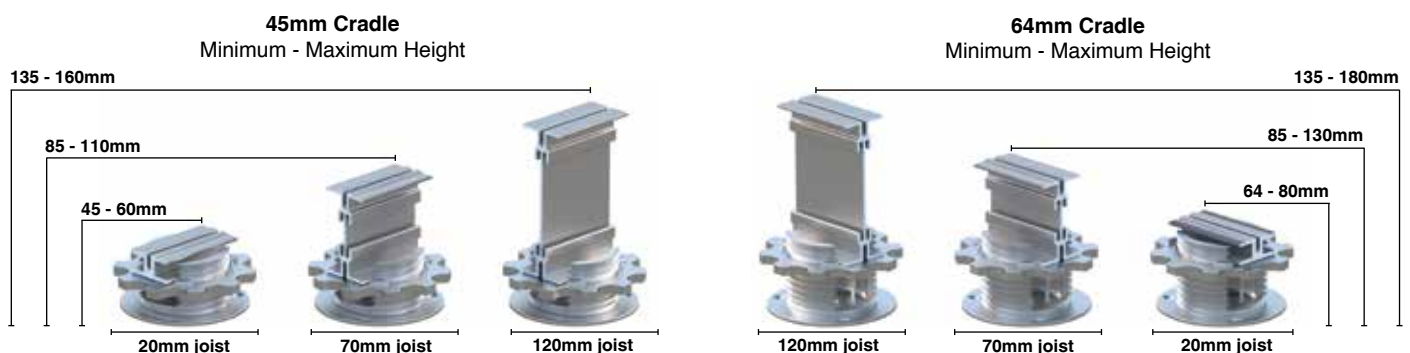
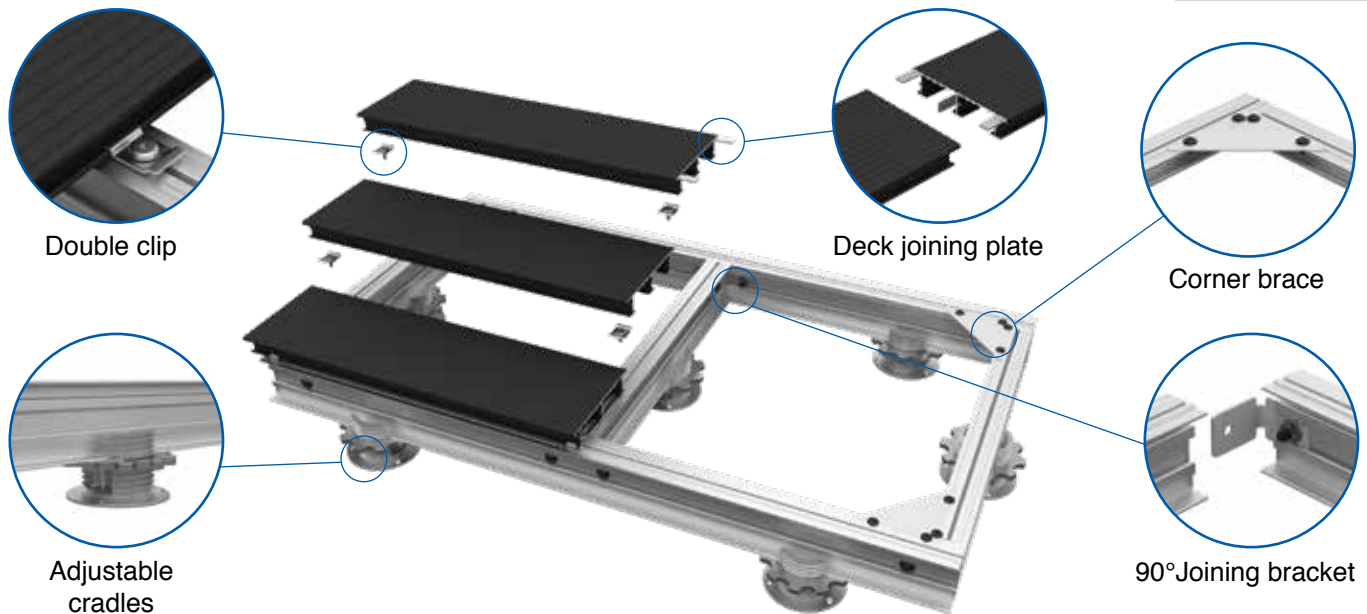

Steel
Wrought Iron Components
Gate Hardware
Sliding Door Gear
Gate Automation
Mesh
Decking & Subframe
Flooring & Stair Treads
Handrailing
Fencing
Fixings



Synergised™ Original

Innovative fire rated aluminium decking solutions

Deck Boards

Anthracite

Black

Serengeti Sand

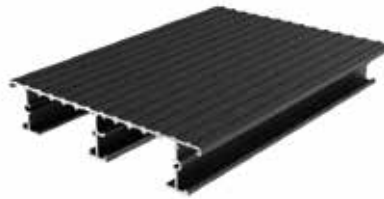
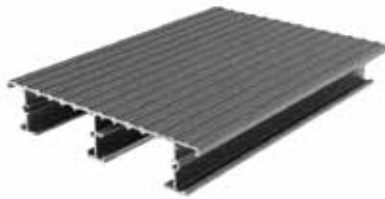

Length mm	Width mm	Depth mm	Code
3600	145	30	79DB30A

RAL 7016.

Length mm	Width mm	Depth mm	Code
3600	145	30	79DB30B

RAL 9005.

Length mm	Width mm	Depth mm	Code
3600	145	30	79DB30SS

RAL 1019.

End Caps

Anthracite

Black

Serengeti Sand

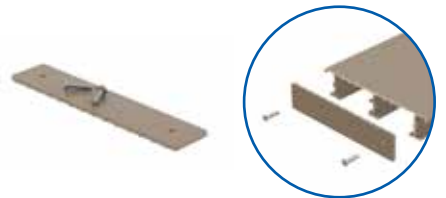
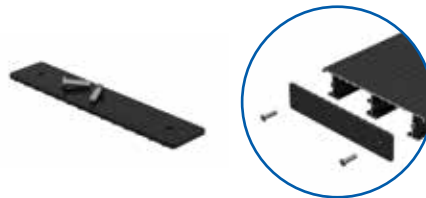
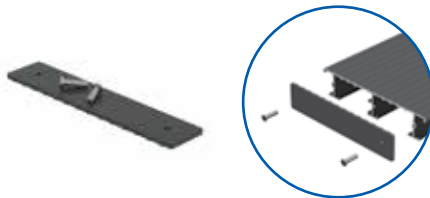

Code
79DBEC30A

Ral 7016. Supplied with all fixings. Requires Torx15 bit, code: 79TX001.

Code
79DBEC30B

Ral 9005. Supplied with all fixings. Requires Torx15 bit, code: 79TX001.

Code
79DBEC30SS

Ral 1019. Supplied with all fixings. Requires Torx15 bit, code: 79TX001.

Deck Joining Plate

Starter Clip

Double Clip

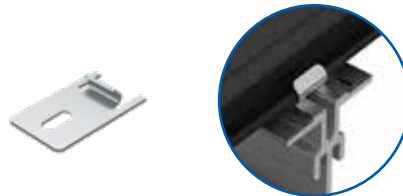
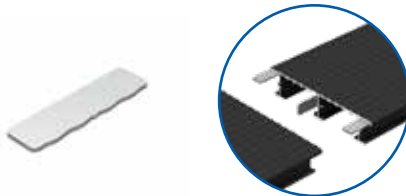

Quantity	Code
100	79DJP

3 per join.

Quantity	Code
1	79DSC01

Use 4 per full length board. For screws, use code: **79SS**.

Quantity	Code
1	79DC01

Use 4 per full length board. Leaves 5mm gap between deck boards. For screws, use code: **79SS**.

Screws

For starter, double clips & joist mounting clips

Torx15 Bit

For end cap fixings

Torx40 Bit

For 90° brackets fixings

Touch Up Paint

For deck boards



Ø mm	Length mm	Code
4.8	13	79SS

Pack quantity 100.

Quantity	Code
1	79TX001

25mm long.

Quantity	Code
1	79TX002

25mm long.

ml	Colour	Code
400	Anthracite RAL 7016	29PC400SASY
400	Black RAL 9005	29PC400SBSY
400	Serengeti Sand RAL 1019	29PC400SSSY

Scan here to order a free deck board or joist sample.



Synergised™ Original

Innovative fire rated aluminium decking solutions



Joists

20mm Profile

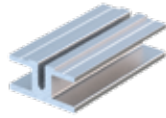

Length mm	Width mm	Height mm	Code
3600	40	20	79J020

70mm Profile



Length mm	Width mm	Height mm	Code
3600	40	70	79J070

120mm Profile

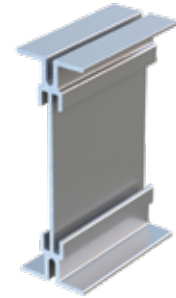

Length mm	Width mm	Height mm	Code
3600	40	120	79J120

Joist Joining Kits

Corner Brace

To suit 20 / 70mm joist profiles

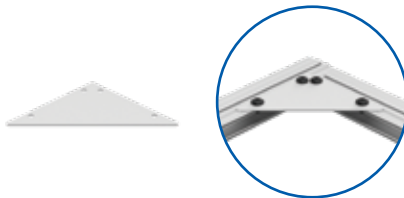

Quantity	Code
1	79CB20

Supplied with all fixings. Drill 3.5mm pilot holes into joists. Requires Pozi-Drive bit to tighten.

90° Bracket

To suit 70mm joist profile



Quantity	Code
4	79JBK70

Supplied with all fixings. Drill 8.5mm pilot holes into joists. Requires Torx40 bit, code: 79TX002.

90° Bracket

To suit 120mm joist profile



Quantity	Code
4	79JBK120

Supplied with all fixings. Drill 8.5mm pilot holes into joists. Requires Torx40 bit, code: 79TX002.

Joist Mounting Clip

To suit 70 / 120mm joist profiles

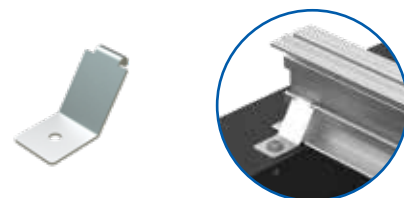

Quantity	Code
1	79MP01

Used to mount the joist to the floor, existing subframe or to stack joists. For screws to stack joist to joist, use code: 79SS.

Adjustable Cradles

45mm



Code
79PED45

Minimum height 45mm. Maximum height 160mm.

64mm

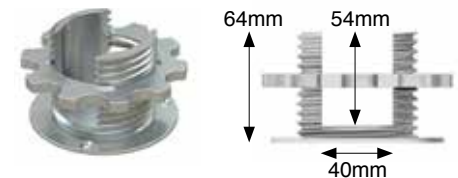

Code
79PED64

Minimum height 64mm. Maximum height 180mm.

Synergised™ Paving Clips

Suitable for 2cm thick tiles

Paving End Stop



Code
79PES01

Use with Synergised subframe.

Paving Plate



Code
79PP01

Use with Synergised subframe.

Screw



Size mm	Code
4.2 x 16	5004CS4216

Pack quantity 200





The latest offering to our aluminium decking range is the Synergised Connected system. It is manufactured from structural grade 6063 T6 Aluminium, and supplied with a non-slip powder coated finish. Its unique interlocking boards allows the system to stay seamlessly connected, whilst offering integrated drainage channels, to direct rainwater away from under the deck. All boards are discreetly and quickly fixed onto the substructure, before fixings are hidden from view, by the next adjoining board.

- Cost effective, quick & easy to install
- Fully non-combustible
- No gaps between boards
- Integrated drainage channels
- Non-slip design
- Powder coated anthracite RAL 7016
- 10 year warranty on powder coating
- Compatible with Synergised subframe and cradles

It Takes Just Three Different Extrusions To Build An Entire Deck...

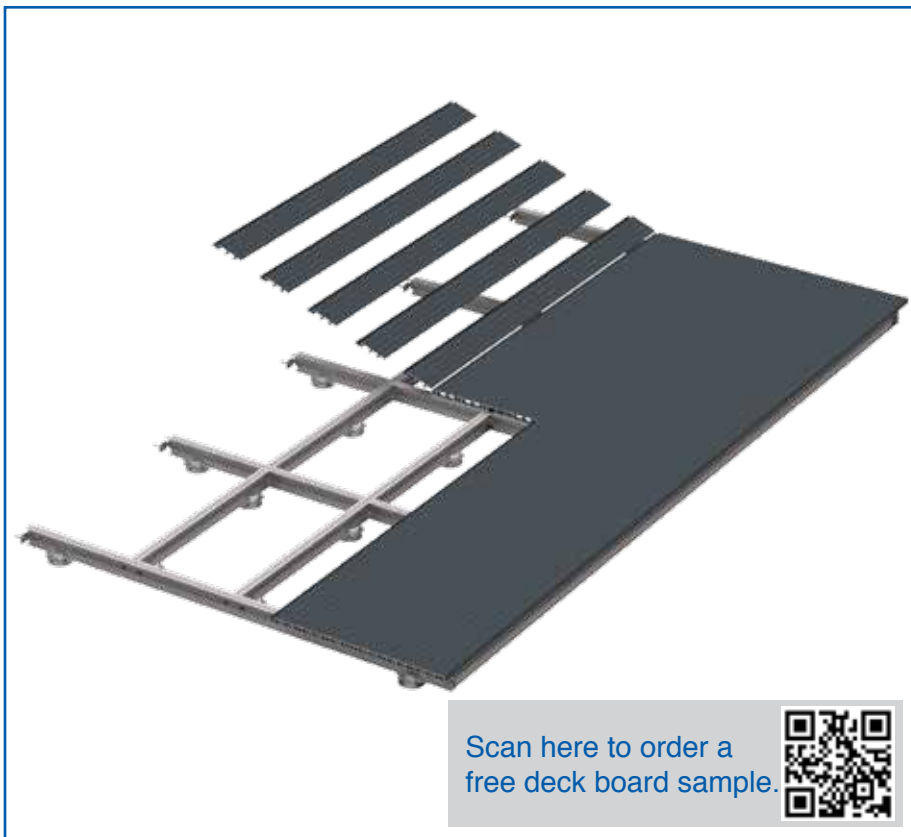

Scan here to order a free deck board sample.

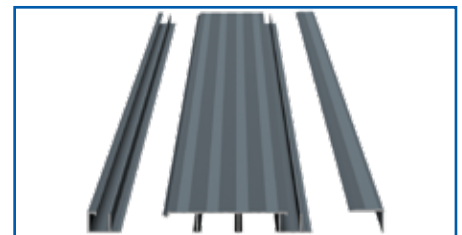

Starter trim, deck board and edging trim.



Screw down boards to subframe.



Fixing a single deck board to a joist.



Joining two deck boards to a joist.

Synergised Connected comes in a non-slip anthracite RAL 7016 finish.

- Starter Trim
- Deck Board
- Edging Trim

These sections can be screwed directly onto any subframe or substrate.

Synergised™ Connected

Innovative non-combustible aluminium decking solutions



How To Install Your Deck:



Screw down the starter trim.



Connect your first board.



Screw down the deck board.



Connect next board and repeat.

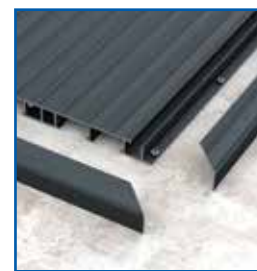

Screw down final board and mitre edging trim.

The end result is a fully connected Synergised decking system with integrated drainage channels.



Image shows how water is drained from the deck.



Your fully connected board is ready for use.

Starter Trim



Length mm	Width mm	Depth mm	Code
3600	32.98	21.6	79ST22A

RAL 7016.

Deck Board

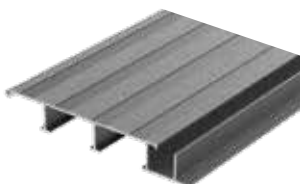

Length mm	Width mm	Depth mm	Code
3600	149	21.6	79DB22A

RAL 7016.

Edging Trim



Length mm	Width mm	Depth mm	Code
3600	34.8	24.4	79ET22A

RAL 7016.

Fixings For Concrete

Pan Head Screw



Ø mm	Length mm	Code
6	40	5002MS640

Pack quantity 100.

Fixings For Aluminium

Screws

For starter trim and deck boards



Ø mm	Length mm	Code
4.8	13	79SS

Pack quantity 100.

Fixings For Edging Trim

Self Tapping Screw

For fixing edge trims



Ø mm	Length mm	Code
3.5	16	5002CS658B

PZ2 CSK Black. Pack quantity 200.

Can be used as a tile tray or base for Synergised Porcelain Tiles & Perimeter Base System



For subframe see page 376.



For porcelain tiles see page 379.

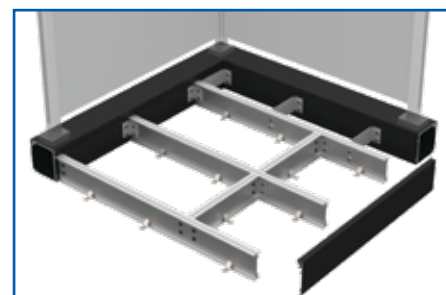

For perimeter base system see page 382.



As part of our Synergised framing & decking program the La Fabbrica collection of porcelain stoneware reaches new heights in style and engineering, taking all the beauty and charm of the finest timbers. Safe, sustainable, versatile, and refined, Italian excellence with unbeatable quality. The tiles can flow seamlessly from inside your house to outside, changing only the surface texture with the designs dominated by the warmth and texture of wood. Whether on flat ground, a raised patio or high-rise balcony, you can now step out of your house onto porcelain tiles that look like natural wood. And it's fire rated too covering all current and proposed fire regulations.

Ca' Foscari recreates the warmth and natural appearance of textured wood, while the knots and veining in Yosemite convey the warm and traditional recreation of wood. Both offer elegant and contemporary style to any setting, whether residential or commercial it offers a long lasting low maintenance solution.

- Stunning wood effect Italian porcelain from one of Italy's top design houses
- Fully non-combustible
- Low surface temperatures
- Ideal for elevated patios, all decking applications, and all types of balconies
- Build your dream elevated stone patio without the need for expensive retaining walls and backfill materials
- 800mm joist spacing for tile support trays
- Dramatic reduction in hard landscaping costs
- Perimeter base section allows for our wide range of handrail systems to be fully integrated into your project

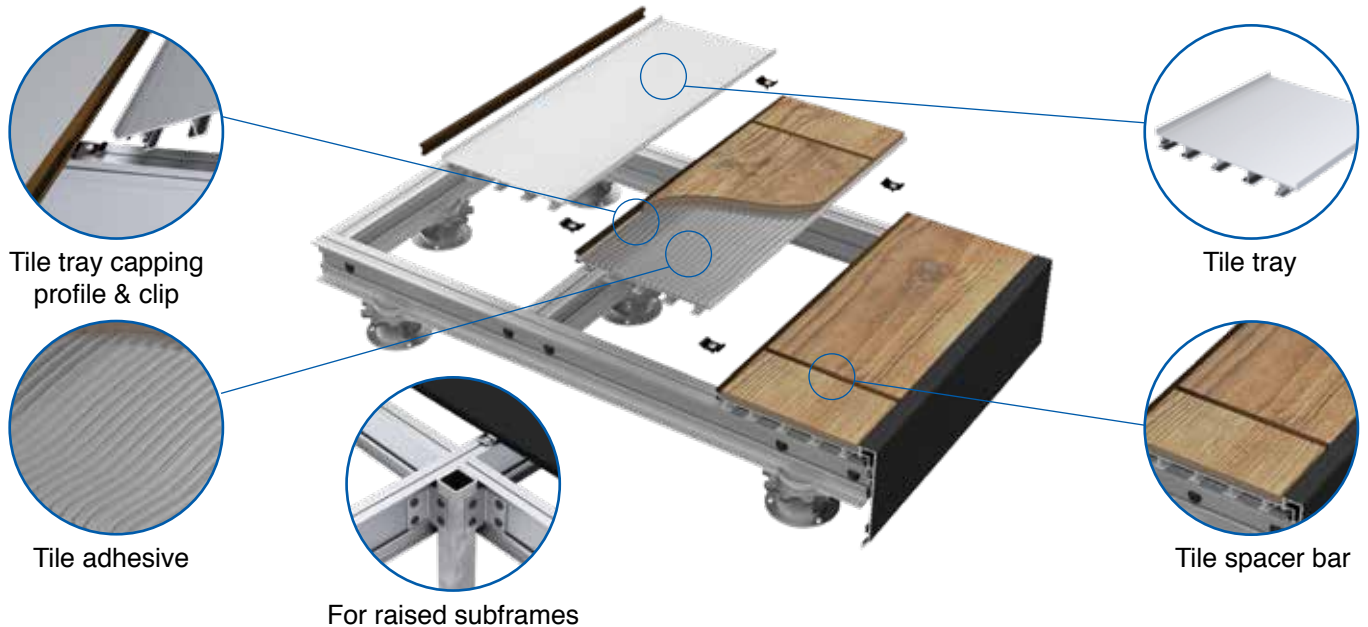

New Raised Patio



Existing Subframe



Cantilever Balcony



Concrete inset Balcony



The perimeter base section allows for our wide range of handrail systems to be fully integrated see page 382.

Synergised™ Porcelain Tiles

External decking solutions



- Steel
- Wrought Iron Components
- Gate Hardware
- Sliding Door Gear
- Gate Automation
- Mesh
- Decking & Subframe
- Flooring & Stair Treads
- Handrailing
- Fencing
- Fixings



Ca'Foscari Collection

Avana

Canapa

Lino

Moro

Tobacco



Code
79P1221AE

Code
79P1221CE

Code
79P1221LE

Code
79P1221ME

Code
79P1221TE

Tile size: L 1200 x W 200 x D 10mm. Supplied as box of 4.

Tile Tray

Joining Plate

Starter Clip

Double Clip

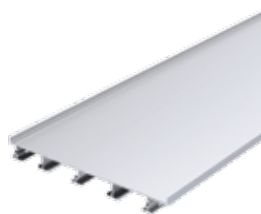

L x W x D mm	Code
3600 x 200 x 30	79TT30

Requires 2 joining plates per join, code: **79DJP**. Mill finish.

Quantity	Code
100	79DJP

2 per join. For use with tile tray code: **79TT30**.

Quantity	Code
1	79DSC01

Use 4 per full length tile tray code: **79TT30**. For screws, use code: **79SS**.

Quantity	Code
1	79TTDC01

For joining tile trays code: **79TT30**.



Free delivery on all orders over £150.00

Scan here to order a free sample.





Synergised™ Porcelain Tiles

External decking solutions

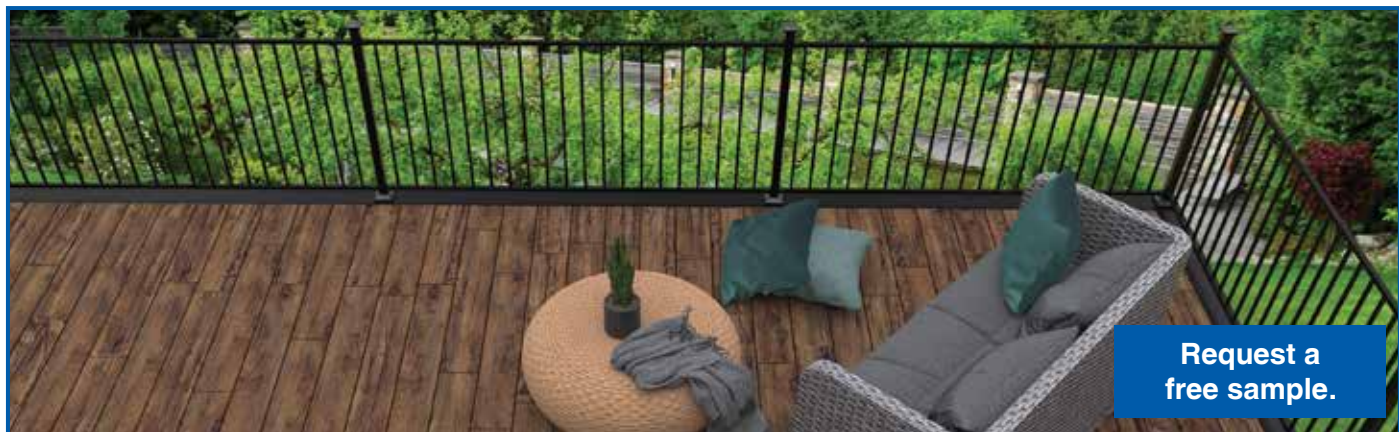

Yosemite Collection

Mulberry



Code
79P1221YME

Olive



Code
79P1221YOE

Shell



Code
79P1221YSE

Tan



Code
79P1221YTE

Walnut



Code
79P1221YWE

Tile size: L 1200 x W 200 x D 10mm. Supplied as box of 4.

Tile Spacers



Quantity	Code
200	79TS2MM

2mm thickness. Space across the width and length of the tile trays underneath the tiles to prevent the porcelain tiles from moving during curing.

Tile Adhesive



Fire Rated

General Purpose

Description	ml	Code
Fire rated	300	79FRTA
General Purpose	290	79GPTA

Tile Tray Capping Profile

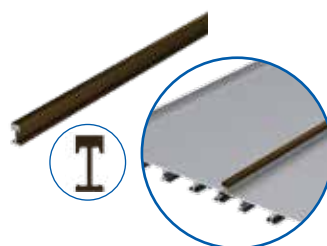

L x W mm	Code
3600 x 8	79TCP

For use with tile tray profile code: 79TT30. Aluminium Grade GT547. Bronze anodised finish.

Tile Spacer Bar



L x W mm	Code
200 x 4	79FSB200

Bronze anodised finish.



You can order online 24 hours a day, 7 days a week. Visit our website: www.fhbrundle.co.uk

Scan here to order a free sample.



Synergised™ Decking System



Perimeter base system

Our unique innovative perimeter base section, bolts directly to the Synergised subframe. It allows for a wide range of our base fix handrailing solutions to be bolted down to the perimeter, to provide a safe, stunning edge protection where there is a fall of more than 600mm. The Internal Perimeter Support Jack provides the strength required to allow handrailing systems to reach the desired residential 0.74kn loading requirements, as per BS6180.

If handrailing is not required, then our Edge Fascia Profile can be fitted to discreetly hide the subframe. The Edge Fascia Profile is supplied powder coated black, to contrast stylishly with the range of ceramic tiles and handrailing solutions, it also perfectly matches the perimeter base section when used alongside on the same project

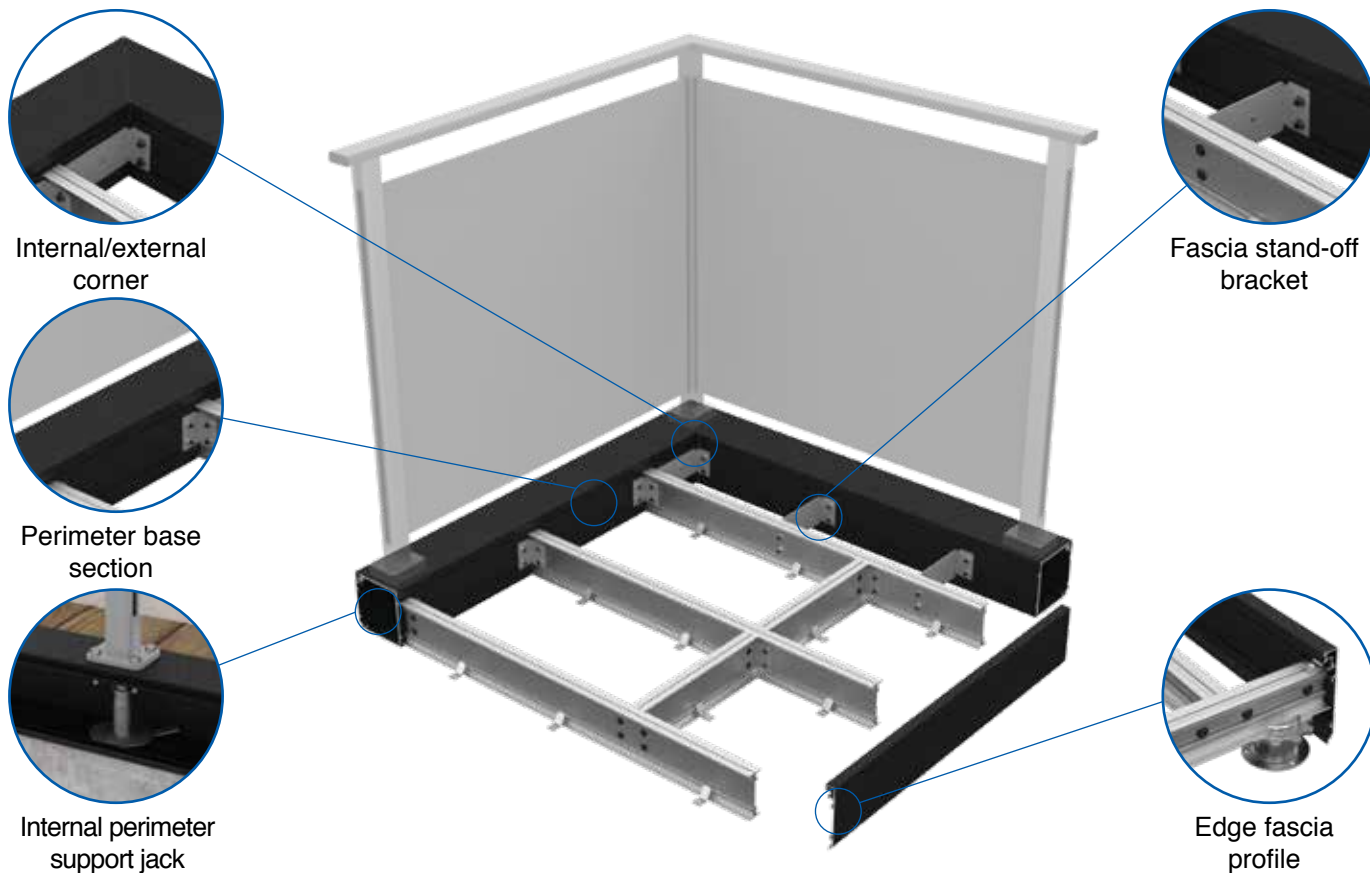

Internal/external corner

Fascia stand-off bracket

Perimeter base section

Internal perimeter support jack

Edge fascia profile

PERIMETER BASE SECTION ASSEMBLY

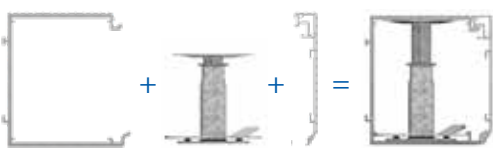

FOR RAISED SUBFRAMES



Perimeter Base Section



L x W x D mm	Code
3600 x 150 x 130	79PPB150B

For use with edge fascia profile code: **79EFB100**. Polyester powder coated black RAL 9005.

Edge Fascia Profile



L x D mm	Code
3600 x 100	79EFB100

Polyester powder coated black RAL 9005.

Internal Corner With Fascia



Size mm	Code
150 x 130	79PPBiCB

External Corner With Fascia



L x D mm	Code
3600 x 100	79PPBECB

Internal Perimeter Support Jack

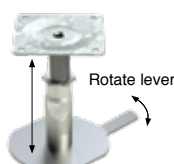

Code
79PBSP01

Adjust to desired height and rotate lever to lock in place.

Fascia Stand-Off Bracket



Code
79TBC

For use with perimeter base section code: **79PB150B**. Stainless steel.



Enhance the beauty and functionality of your space with our innovative range of low-profile deck finishing trims, designed to complement or accent most composite UPVC and aluminium deck boards on the UK market. Our edge and corner trims will provide you with the opportunity to cap-off those edges, corners, and exposed areas of decks or steps, enabling you to finish and seal your new decking area. All trims are manufactured from 6063 T6 grade aluminium, meaning you get a durable edging to your decking and steps.

Our 40 x 40mm profiles cover all deck board thicknesses, the decking trims will not crack, split, warp or fade and are available in 8 designer RAL colours plus a mill finish to powder coat to a colour of your choice to complement any project.

Oyster White



Length m	Width mm	Depth mm	Code
6	40	40	76A002OW

RAL 1013.

Serengeti Sand



Length m	Width mm	Depth mm	Code
6	40	40	76A002SS

RAL 1019.

Umbra Grey



Length m	Width mm	Depth mm	Code
6	40	40	76A002UG

RAL 7022.

Pebble Grey



Length m	Width mm	Depth mm	Code
6	40	40	76A002LS

RAL 7032.

Mineral Grey



Length m	Width mm	Depth mm	Code
6	40	40	76A002MG

RAL 7045.

Terra Brown



Length m	Width mm	Depth mm	Code
6	40	40	76A002TB

RAL 8028.

Black Sand

Non-slip



Length m	Width mm	Depth mm	Code
3	40	40	76A003BS

RAL 9005. Non-slip coated paint.

Signal Yellow

Non-slip



Length m	Width mm	Depth mm	Code
3	40	40	76A003Y

RAL 1003. Non-slip coated paint.

Mill Finish



Length m	Width mm	Depth mm	Code
3	40	40	76A003R